



MS5637-30BA

Miniature 30 bar Industrial Pressure Sensor

SPECIFICATIONS

- High resolution module
- QFN package 3 x 3 x 0.9 mm³
- Supply voltage: 1.5 to 3.6 V
- Fast conversion down to 0.5 ms
- Low power, 0.6 μ A (standby \leq 0.1 μ A at 25°C)
- Integrated digital pressure sensor (24 bit $\Delta\Sigma$ ADC)
- Operating range: 0 to 30 bar, -20 to +85 °C
- I²C interface
- No external components (internal oscillator)

The MS5637-30BA is a new generation of high resolution miniature industrial pressure sensors from MEAS Switzerland with I²C bus interface. It is optimized for air pressure measurement systems with a resolution of 0.5 mbar. The sensor module includes a highly linear pressure sensor and an ultra low power 24 bit $\Delta\Sigma$ ADC with internal factory calibrated coefficients. It provides a precise digital 24 bit pressure and temperature value and different operation modes that allow the user to optimize for conversion speed and current consumption.

A high resolution temperature output allows the implementation of a pressure measurement systems and thermometer function without any additional sensor. The MS5637-30BA can be interfaced to virtually any microcontroller. The communication protocol is simple, without the need to programming internal registers in the device. The antimagnetic stainless steel cap protects the pressure die. This new sensor module generation is based on leading MEMS technology and latest benefits from the MEAS Switzerland proven experience and know-how in high volume manufacturing of pressure modules have been widely used for over a decade.

FEATURES

FIELD OF APPLICATION

- Industrial
- Tire Pressure Monitoring
- Compressor

TECHNICAL DATA

Sensor Performances ($V_{DD} = 3\text{ V}$)				
Pressure	Min	Typ	Max	Unit
Range	0		30	bar
ADC	24			bit
Resolution (OSR=8192)	0.27			mbar
Error band, 0°C to +40°C, 0.3 to 14 bar		±50		mbar
Error band, -20°C to +85°C, 0.3 to 30 bar		±150		mbar
Response time (1)	0.5/1.1/2.1/4.1 / 8.22 / 16.44			ms
Long term stability		±30		mbar/yr
Temperature	Min	Typ	Max	Unit
Range	-20		+85	°C
Resolution		<0.01		°C
Accuracy at 25°C		±2		°C
Notes: (1) Oversampling Ratio: 256 / 512 / 1024 / 2048 / 4096 / 8192				

PERFORMANCE SPECIFICATIONS

ABSOLUTE MAXIMUM RATINGS

Parameter	Symbol	Conditions	Min.	Typ.	Max.	Unit
Supply voltage	V _{DD}		-0.3		+3.6	V
Storage temperature	T _S		-20		+85	°C
Overpressure	P _{max}			50		bar
Maximum Soldering Temperature	T _{max}	40 sec max			250	°C
ESD rating		Human Body Model	-2		2	kV
Latch up		JEDEC standard No 78	-100		100	mA

ELECTRICAL CHARACTERISTICS

Parameter	Symbol	Conditions	Min.	Typ.	Max.	Unit
Operating Supply voltage	V _{DD}		1.5	3.0	3.6	V
Operating Temperature	T		-20	+25	+85	°C
Supply current (1 sample per sec.)	I _{DD}	OSR 8192 4096 2048 1024 512 256		20.09 10.05 5.02 2.51 1.26 0.63		µA
Peak supply current		during conversion		1.25		mA
Standby supply current		at 25°C (V _{DD} = 3.0 V)		0.01	0.1	µA
VDD Capacitor		from VDD to GND	100	470		nF

ANALOG DIGITAL CONVERTER (ADC)

Parameter	Symbol	Conditions	Min.	Typ.	Max.	Unit
Output Word				24		bit
Conversion time	t _c	OSR 8192 4096 2048 1024 512 256		16.44 8.22 4.13 2.08 1.06 0.54	18.1 9.04 4.54 2.28 1.17 0.60	ms

PERFORMANCE SPECIFICATIONS (CONTINUED)

PRESSURE OUTPUT CHARACTERISTICS ($V_{DD} = 3.0\text{ V}$, $T = 25\text{ }^{\circ}\text{C}$ UNLESS OTHERWISE NOTED)

Parameter	Conditions	Min.	Typ.	Max.	Unit
Operating Pressure Range	P_{range}	0.3		30	bar
Absolute Accuracy, no autozero	0.3..14 bar, 0..40°C 0.3..30 bar, -20..85°C		±50 ±150		mbar
Resolution RMS	OSR 8192 4096 2048 1024 512 256		0.27 0.38 0.54 0.78 1.14 1.83		mbar
Maximum error with supply voltage	$V_{DD} = 1.5\text{ V} \dots 3.6\text{ V}$		±50		mbar
Long-term stability			±30		mbar/yr
Reflow soldering impact	IPC/JEDEC J-STD-020C (See application note AN808 on http://meas-spec.com)		±5		mbar
Recovering time after reflow (2)			5		days

(1) Characterized value performed on qualification devices

(2) Recovering time at least 66% of the reflow impact

TEMPERATURE OUTPUT CHARACTERISTICS ($V_{DD} = 3\text{ V}$, $T = 25\text{ }^{\circ}\text{C}$ UNLESS OTHERWISE NOTED)

Parameter	Conditions	Min.	Typ.	Max.	Unit
Absolute Accuracy	At 25°C -20..85°C		±2 ±3		°C
Maximum error with supply voltage	$V_{DD} = 1.5\text{ V} \dots 3.6\text{ V}$		±0.5		°C
Resolution RMS	OSR 8192 4096 2048 1024 512 256		0.0022 0.0026 0.0033 0.0041 0.0055 0.0086		°C

PERFORMANCE SPECIFICATIONS (CONTINUED)**DIGITAL INPUTS (SDA, SCL)**

Parameter	Symbol	Conditions	Min.	Typ.	Max.	Unit
Serial data clock	SCL				400	kHz
Input high voltage	V _{IH}		80% V _{DD}		100% V _{DD}	V
Input low voltage	V _{IL}		0% V _{DD}		20% V _{DD}	V
Input leakage current	I _{leak}	at 25 °C			0.1	μA
Input capacitance	C _{IN}			6		pF

DIGITAL OUTPUTS (SDA)

Parameter	Symbol	Conditions	Min.	Typ.	Max.	Unit
Output high voltage	V _{OH}	I _{source} = 0.6 mA	80% V _{DD}		100% V _{DD}	V
Output low voltage	V _{OL}	I _{sink} = 0.6 mA	0% V _{DD}		20% V _{DD}	V
Load capacitance	C _{LOAD}			16		pF

PERFORMANCE CHARACTERISTICS

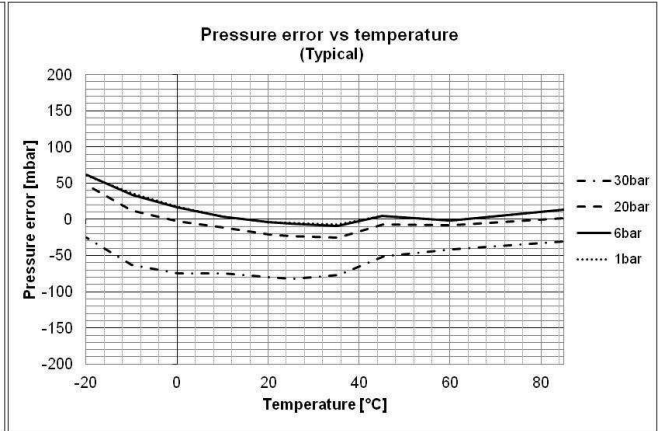
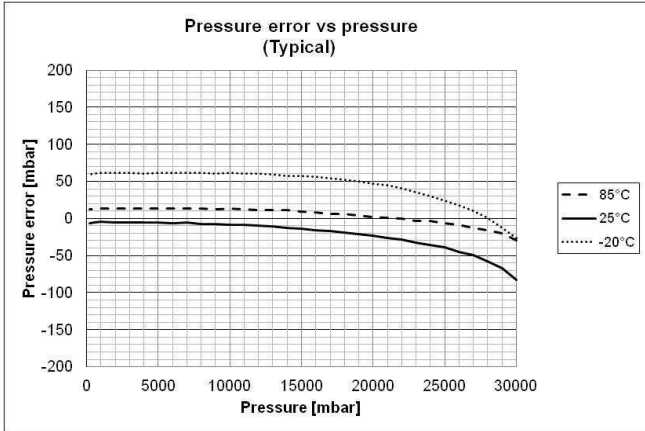

TEMPERATURE ERROR VS TEMPERATURE

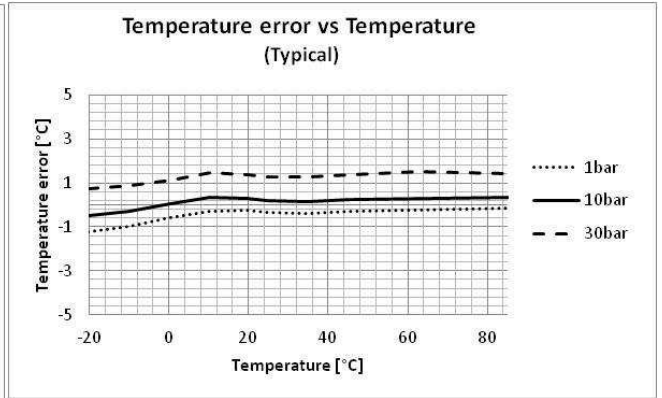
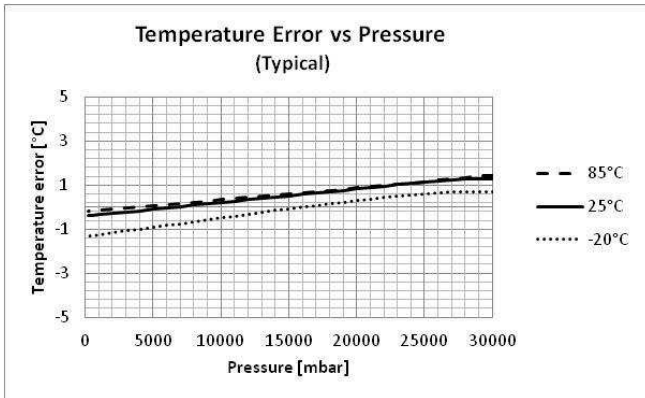

PRESSURE AND TEMPERATURE VS POWER SUPPLY VOLTAGE

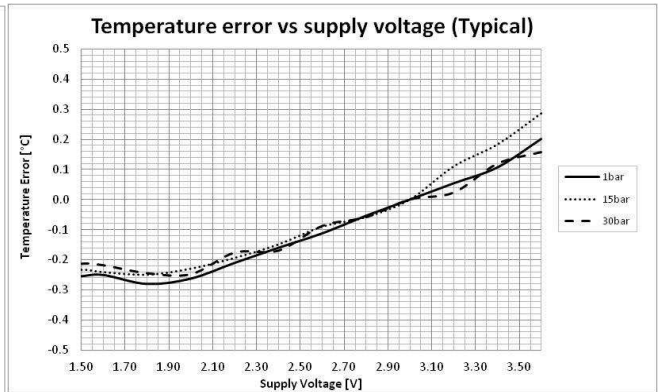
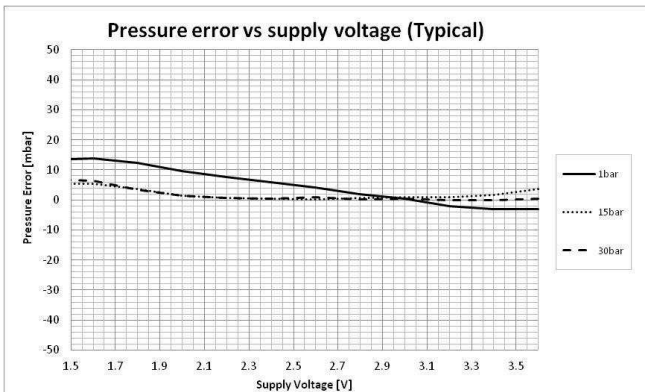

FUNCTIONAL DESCRIPTION

GENERAL

The MS5637 consists of a piezo-resistive sensor and a sensor interface integrated circuit. The main function of the MS5637 is to convert the uncompensated analogue output voltage from the piezo-resistive pressure sensor to a 24-bit digital value, as well as providing a 24-bit digital value for the temperature of the sensor.

FACTORY CALIBRATION

Every module is individually factory calibrated at two temperatures and two pressures. As a result, 6 coefficients necessary to compensate for process variations and temperature variations are calculated and stored in the 112-bit PROM of each module. These bits (partitioned into 6 coefficients) must be read by the microcontroller software and used in the program converting D1 and D2 into compensated pressure and temperature values. The first PROM coefficient contains factory configuration and CRC.

SERIAL I2C INTERFACE

The external microcontroller clocks in the data through the input SCL (Serial CLock) and SDA (Serial DAta). The sensor responds on the same pin SDA which is bidirectional for the I²C bus interface. So this interface type uses only 2 signal lines and does not require a chip select.

Module reference	Mode	Pins used
MS563730BA03	I ² C	SDA, SCL

PRESSURE AND TEMPERATURE CALCULATION

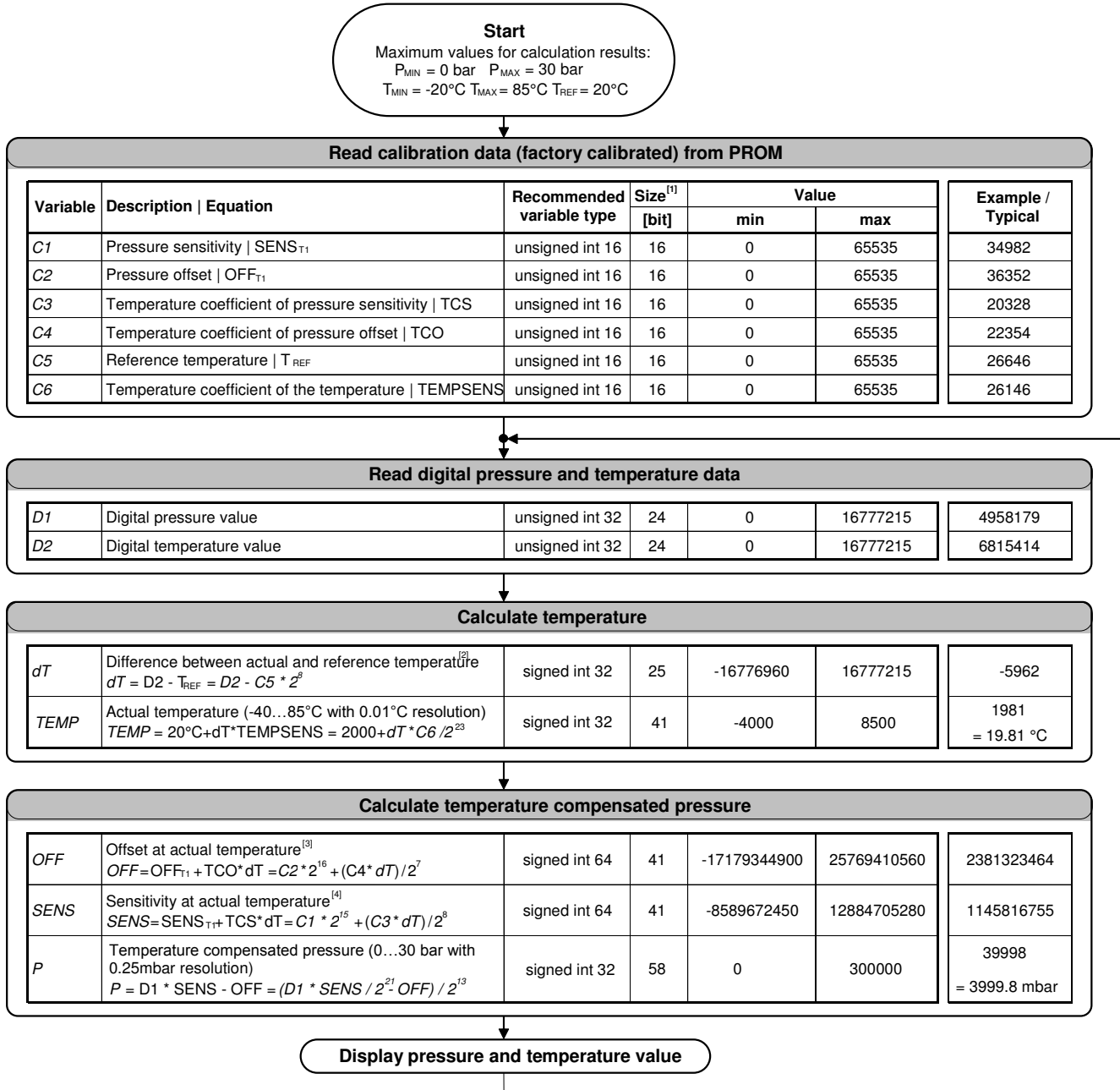

Notes

- [1] Maximal size of intermediate result during evaluation of variable
- [2] min and max have to be defined
- [3] min and max have to be defined
- [4] min and max have to be defined

Figure 1: Flow chart for pressure and temperature reading and software compensation.

SECOND ORDER TEMPERATURE COMPENSATION

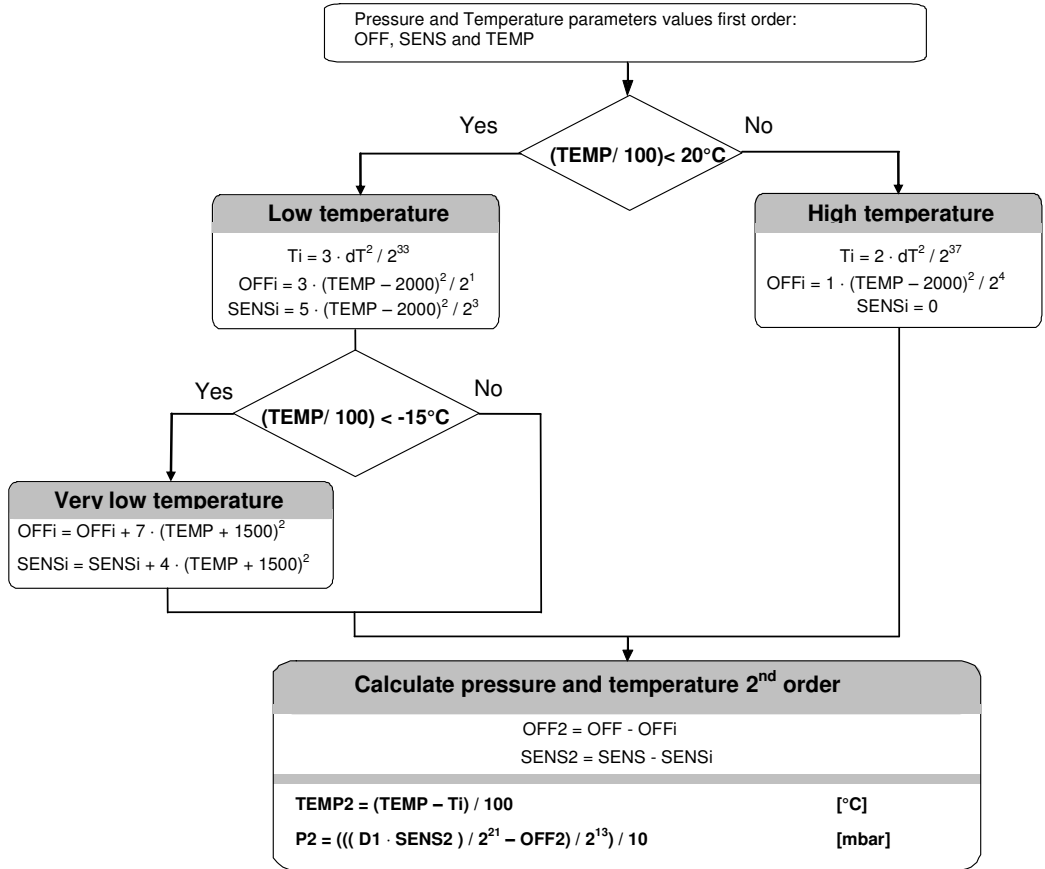

Figure 2: Flow chart for pressure and temperature to the optimum accuracy.

I²C INTERFACE

COMMANDS

The MS5637 has only five basic commands:

1. Reset
2. Read PROM (112 bit of calibration words)
3. D1 conversion
4. D2 conversion
5. Read ADC result (24 bit pressure / temperature)

Each I²C communication message starts with the start condition and it is ended with the stop condition. The MS5637 address is 1110110x (write : x=0, read : x=1).

Size of each command is 1 byte (8 bits) as described in the table below. After ADC read commands, the device will return 24 bit result and after the PROM read 16 bit results. The address of the PROM is embedded inside of the PROM read command using the a2, a1 and a0 bits.

Bit number	Command byte								hex value
	0	1	2	3	4	5	6	7	
Bit name	PRO M	CO NV	-	Typ	Ad2/ Os2	Ad1/ Os1	Ad0/ Os0	Stop	
Command									
Reset	0	0	0	1	1	1	1	0	0x1E
Convert D1 (OSR=256)	0	1	0	0	0	0	0	0	0x40
Convert D1 (OSR=512)	0	1	0	0	0	0	1	0	0x42
Convert D1 (OSR=1024)	0	1	0	0	0	1	0	0	0x44
Convert D1 (OSR=2048)	0	1	0	0	0	1	1	0	0x46
Convert D1 (OSR=4096)	0	1	0	0	1	0	0	0	0x48
Convert D1 (OSR=8192)	0	1	0	0	1	0	1	0	0x4A
Convert D2 (OSR=256)	0	1	0	1	0	0	0	0	0x50
Convert D2 (OSR=512)	0	1	0	1	0	0	1	0	0x52
Convert D2 (OSR=1024)	0	1	0	1	0	1	0	0	0x54
Convert D2 (OSR=2048)	0	1	0	1	0	1	1	0	0x56
Convert D2 (OSR=4096)	0	1	0	1	1	0	0	0	0x58
Convert D2 (OSR=8192)	0	1	0	1	1	0	1	0	0x5A
ADC Read	0	0	0	0	0	0	0	0	0x00
PROM Read	1	0	1	0	Ad2	Ad1	Ad0	0	0xA0 to 0xAE

Figure 3: Command structure

RESET SEQUENCE

The Reset sequence shall be sent once after power-on to make sure that the calibration PROM gets loaded into the internal register. It can be also used to reset the device PROM from an unknown condition.

The reset can be sent at any time. In the event that there is not a successful power on reset this may be caused by the SDA being blocked by the module in the acknowledge state. The only way to get the MS5637 to function is to send several SCLs followed by a reset sequence or to repeat power on reset.

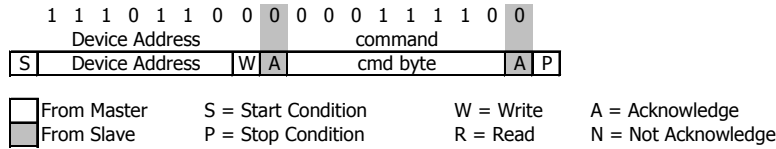

Figure 4: I²C Reset Command

PROM READ SEQUENCE

The read command for PROM shall be executed once after reset by the user to read the content of the calibration PROM and to calculate the calibration coefficients. There are in total 7 addresses resulting in a total memory of 112 bit. Addresses contain factory data and the setup, calibration coefficients, the serial code and CRC. The command sequence is 8 bits long with a 16 bit result which is clocked with the MSB first. The PROM Read command consists of two parts. First command sets up the system into PROM read mode. The second part gets the data from the system.

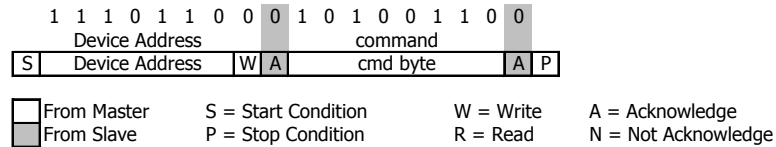

Figure 5: I²C Command to read memory address= 011

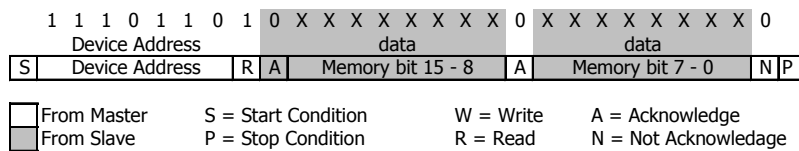

Figure 6: I²C answer from MS5637

CONVERSION SEQUENCE

The conversion command is used to initiate uncompensated pressure (D1) or uncompensated temperature (D2) conversion. After the conversion, using ADC read command the result is clocked out with the MSB first. If the conversion is not executed before the ADC read command, or the ADC read command is repeated, it will give 0 as the output result. If the ADC read command is sent during conversion the result will be 0, the conversion will not stop and the final result will be wrong. Conversion sequence sent during the already started conversion process will yield incorrect result as well. A conversion can be started by sending the command to MS5637. When command is sent to the system it stays busy until conversion is done. When conversion is finished the data can be accessed by sending a Read command, when an acknowledge is sent from the MS5637, 24 SCL cycles may be sent to receive all result bits. Every 8 bits the system waits for an acknowledge signal.

CYCLIC REDUNDANCY CHECK (CRC)

MS5637 contains a PROM memory with 112-Bit. A 4-bit CRC has been implemented to check the data validity in memory. The application note AN520 describes in detail CRC-4 code used.

A	D	D	D	D	D	D	D	D	D	D	D	D	D	D	D	D
d	B	B	B	B	B	B	B	B	B	B	B	B	B	B	B	B
d	1	1	1	1	1	1	1	1	1	1	1	1	1	1	1	0
0	CRC				Factory defined											
1	C1															
2	C2															
3	C3															
4	C4															
5	C5															
6	C6															

Figure 10: Memory PROM mapping

C Code example for CRC-4 calculation:

```

unsigned char crc4(unsigned int n_prom[])           // n_prom defined as 8x unsigned int (n_prom[8])
{
  int cnt;                                         // simple counter
  unsigned int n_rem=0;                           // crc remainder
  unsigned char n_bit;

  n_prom[0]=((n_prom[0]) & 0x0FFF);              // CRC byte is replaced by 0
  n_prom[7]=0;                                    // Subsidiary value, set to 0
  for (cnt = 0; cnt < 16; cnt++)                 // operation is performed on bytes
  {                                               // choose LSB or MSB
    if (cnt%2==1)    n_rem ^= (unsigned short) ((n_prom[cnt]>>1]) & 0x00FF);
    else             n_rem ^= (unsigned short) (n_prom[cnt]>>1]>>8);
    for (n_bit = 8; n_bit > 0; n_bit--)
    {
      if (n_rem & (0x8000))    n_rem = (n_rem << 1) ^ 0x3000;
      else                    n_rem = (n_rem << 1);
    }
  }
  n_rem= ((n_rem >> 12) & 0x000F);              // final 4-bit remainder is CRC code
  return (n_rem ^ 0x00);
}

```

APPLICATION CIRCUIT

The MS5637 is a circuit that can be used in conjunction with a microcontroller in mobile altimeter applications.

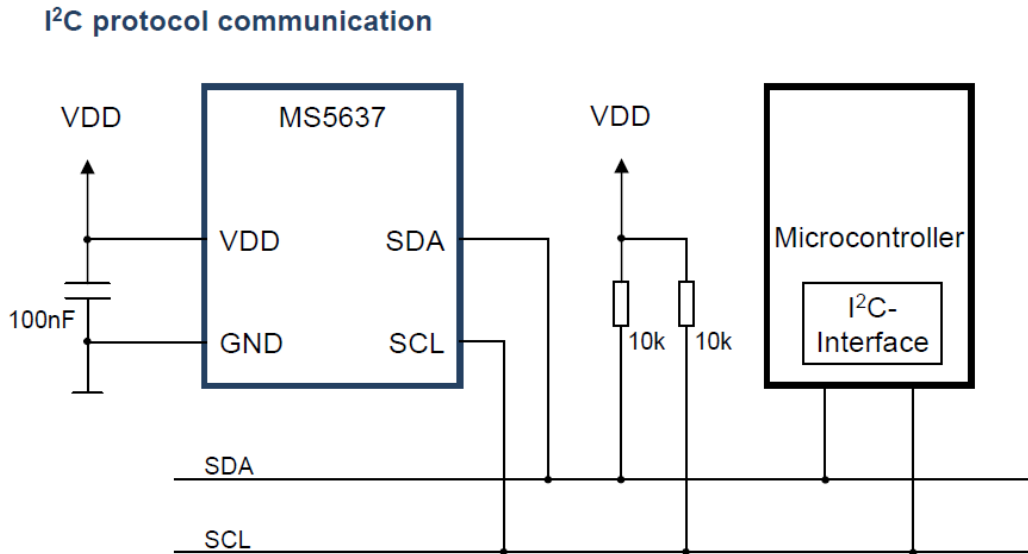

Figure 11: Typical application circuit

MS5637-30BA

Miniature 30 bar Industrial Pressure Sensor

PIN CONFIGURATION

Pin	Name	Type	Function
1	VDD	P	Positive supply voltage
2	SDA	I/O	I ² C data
3	SCL	I	I ² C clock
4	GND	I	Ground

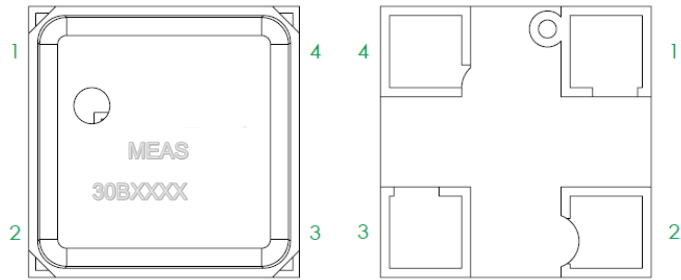

DEVICE PACKAGE OUTLINE

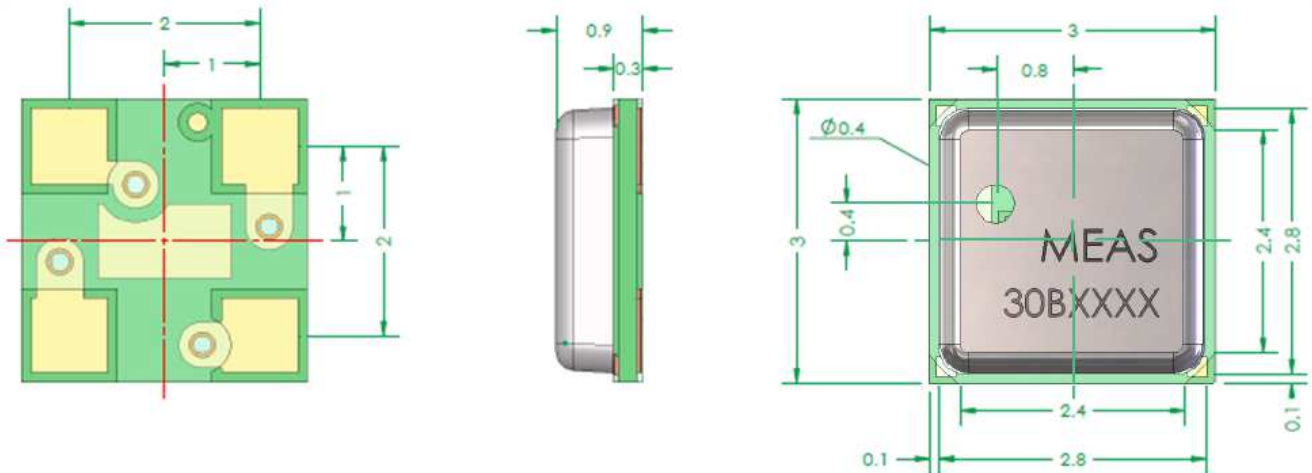

Notes: (1) Dimensions in mm
(2) General tolerance: ± 0.1

Figure 12: MS5637 package outline

RECOMMENDED PAD LAYOUT

Pad layout for bottom side of the MS5637 soldered onto printed circuit board.

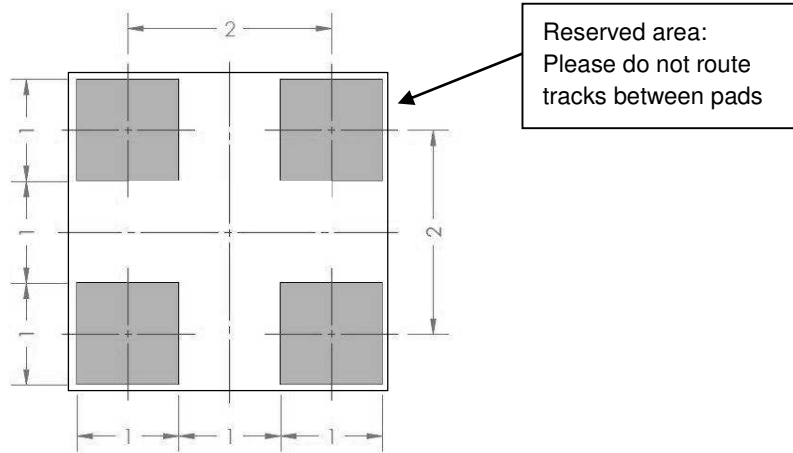
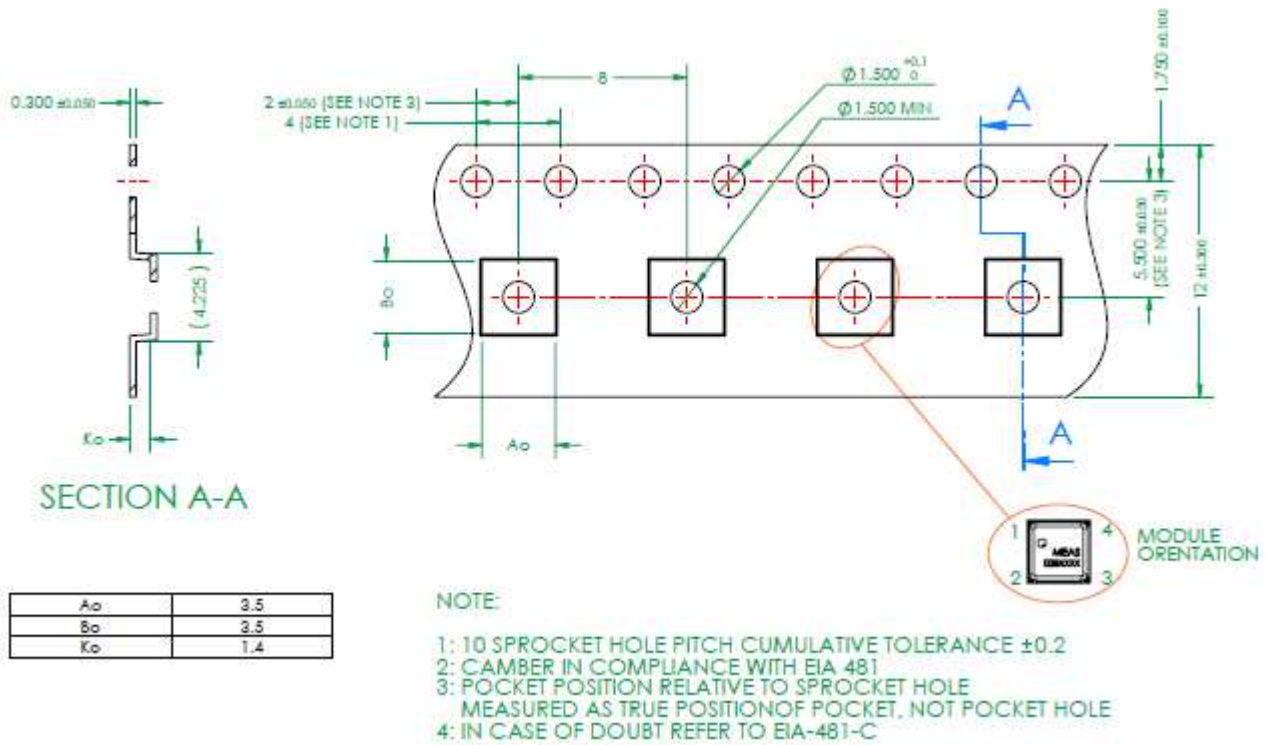

Figure 13: MS5637 pad layout

SHIPPING PACKAGE

Tape and Tape and reel



MOUNTING AND ASSEMBLY CONSIDERATIONS

SOLDERING

Please refer to the application note AN808 available on our website for all soldering issues.

MOUNTING

The MS5637 can be placed with automatic Pick & Place equipment using vacuum nozzles. It will not be damaged by the vacuum. Due to the low stress assembly the sensor does not show pressure hysteresis effects. It is important to solder all contact pads.

CONNECTION TO PCB

The package outline of the module allows the use of a flexible PCB for interconnection. This can be important for applications in watches and other special devices.

CLEANING

The MS5637 has been manufactured under clean-room conditions. It is therefore recommended to assemble the sensor under class 10'000 or better conditions. Should this not be possible, it is recommended to protect the sensor opening during assembly from entering particles and dust. To avoid cleaning of the PCB, solder paste of type "no-clean" shall be used. Cleaning might damage the sensor!

ESD PRECAUTIONS

The electrical contact pads are protected against ESD up to 2 kV HBM (human body model). It is therefore essential to ground machines and personnel properly during assembly and handling of the device. The MS5637 is shipped in antistatic transport boxes. Any test adapters or production transport boxes used during the assembly of the sensor shall be of an equivalent antistatic material.

DECOUPLING CAPACITOR

Particular care must be taken when connecting the device to the power supply. A 100nF minimum ceramic capacitor must be placed as close as possible to the MS5637 VDD pin. This capacitor will stabilize the power supply during data conversion and thus, provide the highest possible accuracy.

MS5637-30BA

Miniature 30 bar Industrial Pressure Sensor

ORDERING INFORMATION

Part Number / Art. Number	Product	Delivery Form
MS563730BA03-50	MS5637-30BA Miniature 30 bar Industrial Pressure Sensor	Tape & Reel

联系方式



深圳市亿为测控电子有限公司
Shenzhen Bill-Well Measurement & Control Electronics Co., Ltd.

地址：深圳市南山区创业路怡海广场东座 2408 邮编：518000

电话：(+86) 0755 2641 9890 传真：(+86) 0755 2641 9680

电子邮箱：sales@bill-well.com